

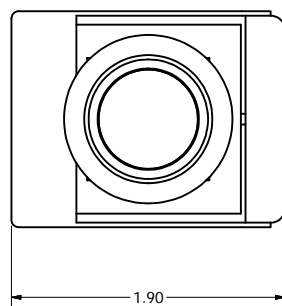

Part Number LV104-2506A-48J	Weight 7.1 lbs (3.23 kg)	
Description LV104 Encl, Dual Power w/2.5-6mm Lens, 48in Pole		http://www.dsmlc.com © 2009 Digital Site Management, L.L.C.

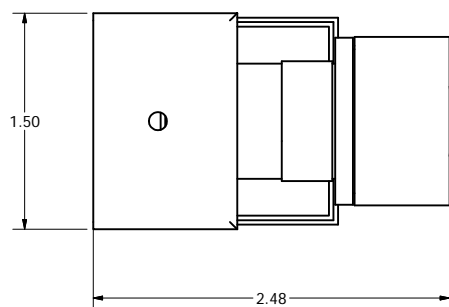
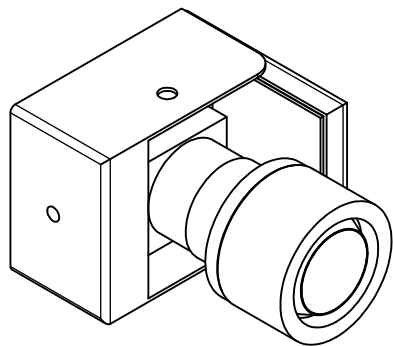

Camera Specifications

Image Picture Element	1/3" Interline CCD	
Scanning Element	NTSC: H15.750KHz/V:59.94Hz	PAL: H15.625KHz/V:50Hz
Effective Picture Element	NTSC: 768(H) 494(V)	PAL: 752(H) 582(V)
Resolution	540 TV Lines	
Minimum Illumination	0.65 Lux (F1.2)	
Synchronizing System	Internal/Line Lock	
White Balance	Auto	
Line Lock	0°-270°: NTSC: 60Hz; PAL: 50Hz	
S/N Ratio	50dB	
Gamma	0.45	
Exposure Control	DC Auto IRIS Drive	
Video Output	1.0Vp-p75Ω	
Lens	2.5-6.0mm	
Backlight Compensation	Central area for auto iris	
Power Range	12 VDC or 24 VAC	
Power Consumption	4.2W (Max)	
Operating Temperature	-10°C to +50°C	
Country of Origin	Taiwan	
Part Number	Weight	
LVC-2506A	0.3 lbs (136 g)	
Description	http://www.dsmlc.com © 2009 Digital Site Management, L.L.C.	
540 TVL, 1/3 CCD, 2.5-6.0mm Lens		